

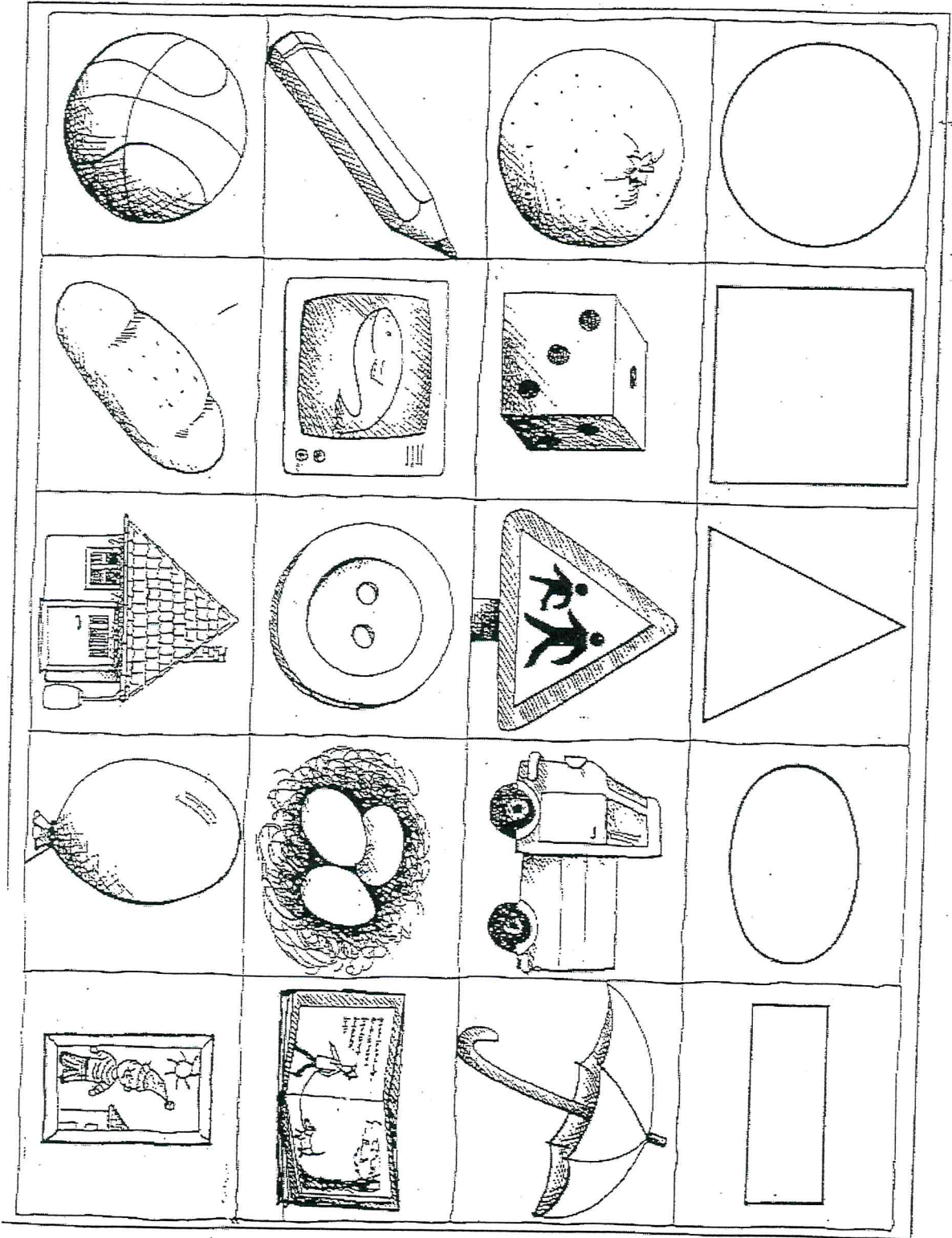

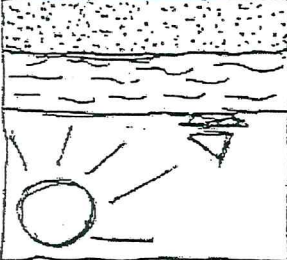

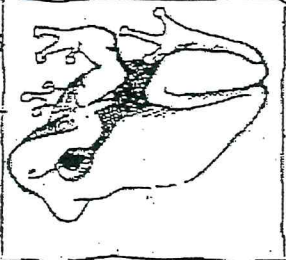

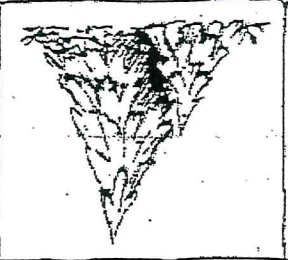
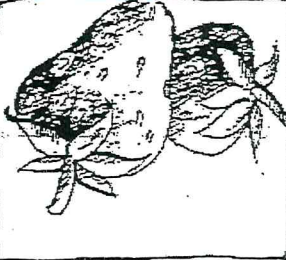
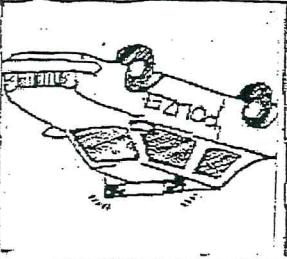

Erkennst du die Formen?

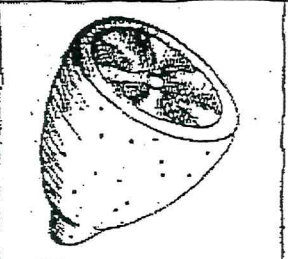
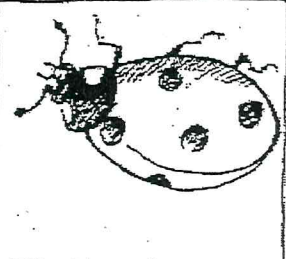
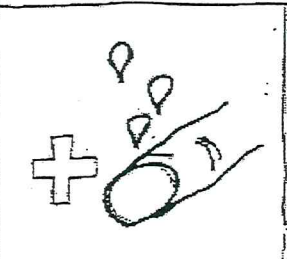

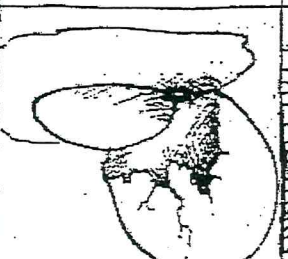
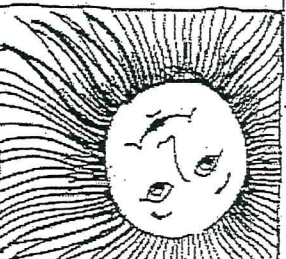
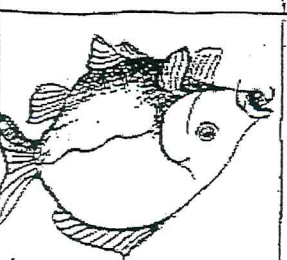
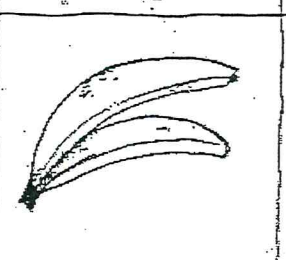
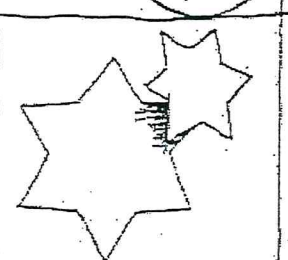
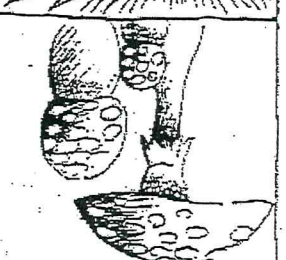
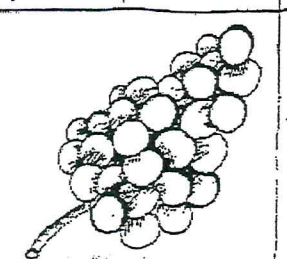
Streiche in jeder Spalte die nicht passende Form durch!  
Male die passenden Formen an!

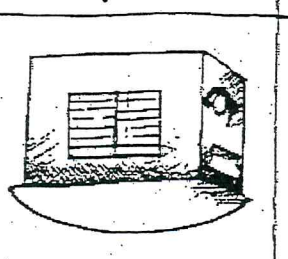
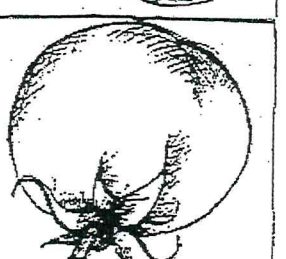
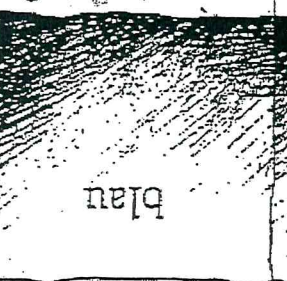
Male die Sachen richtig an!  
Achtung! In jeder Spalte steckt eine Sache, deren Farbe nicht passt!

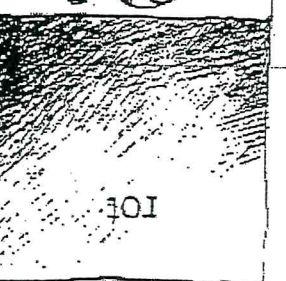
			
			
			
			
			
 blau	 grün	 gelb	 rot

Welche Farbe passt?



Höre die Geräusche-CD an. Was erkennst du wieder? Nummeriere die Bilder in der richtigen Reihenfolge auf!  
Was siehst du auf den Bildern?  
Schneide die Bilder aus und klebe die Bilder in der richtigen Reihenfolge auf!

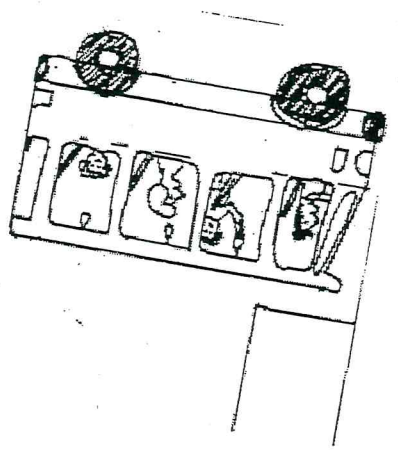
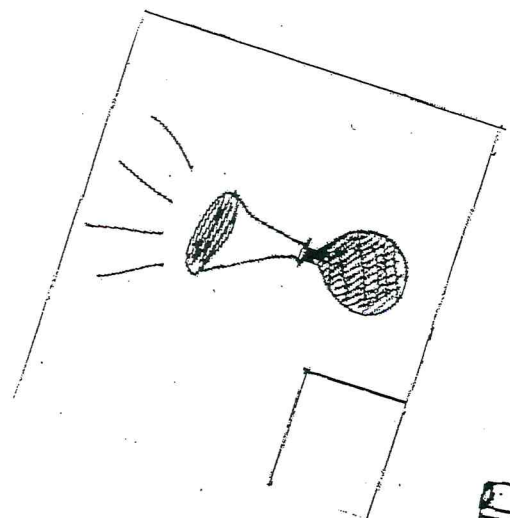
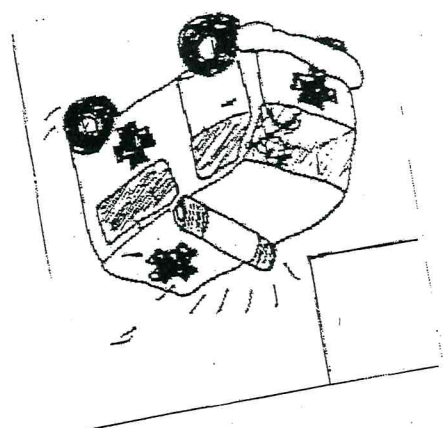
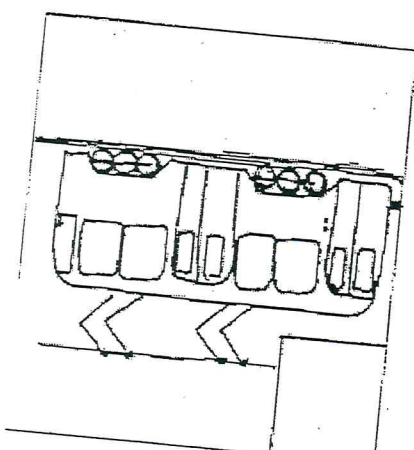
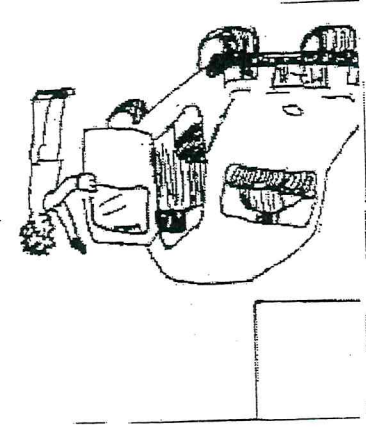
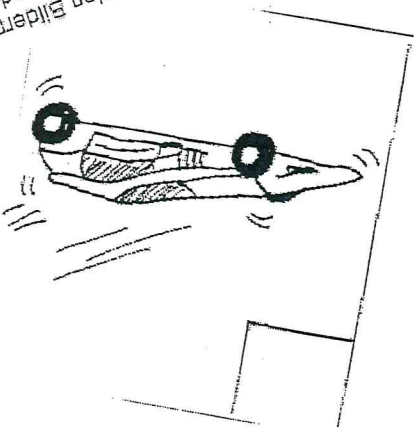
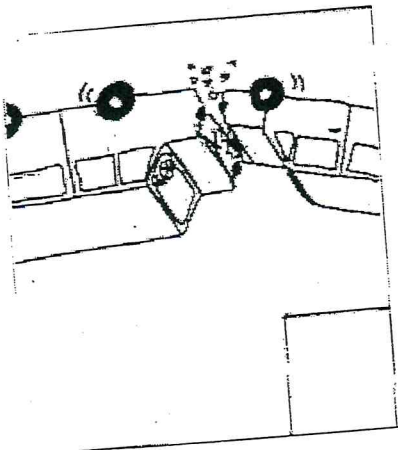
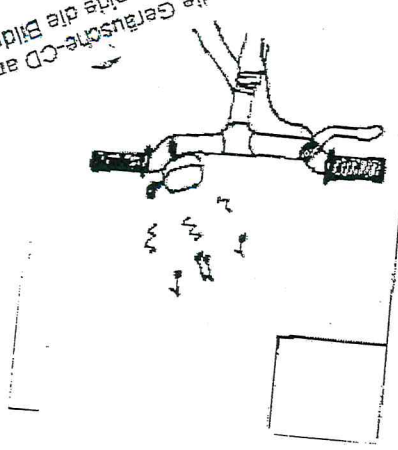
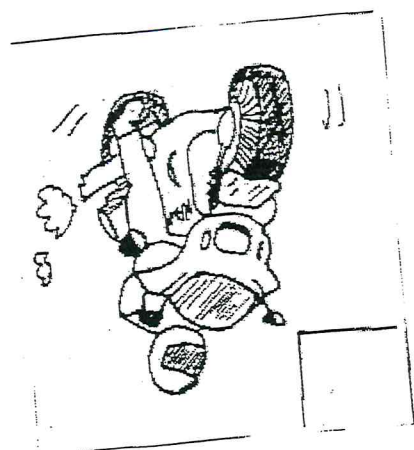

Was hörst Du?

Wer ist schneller ?

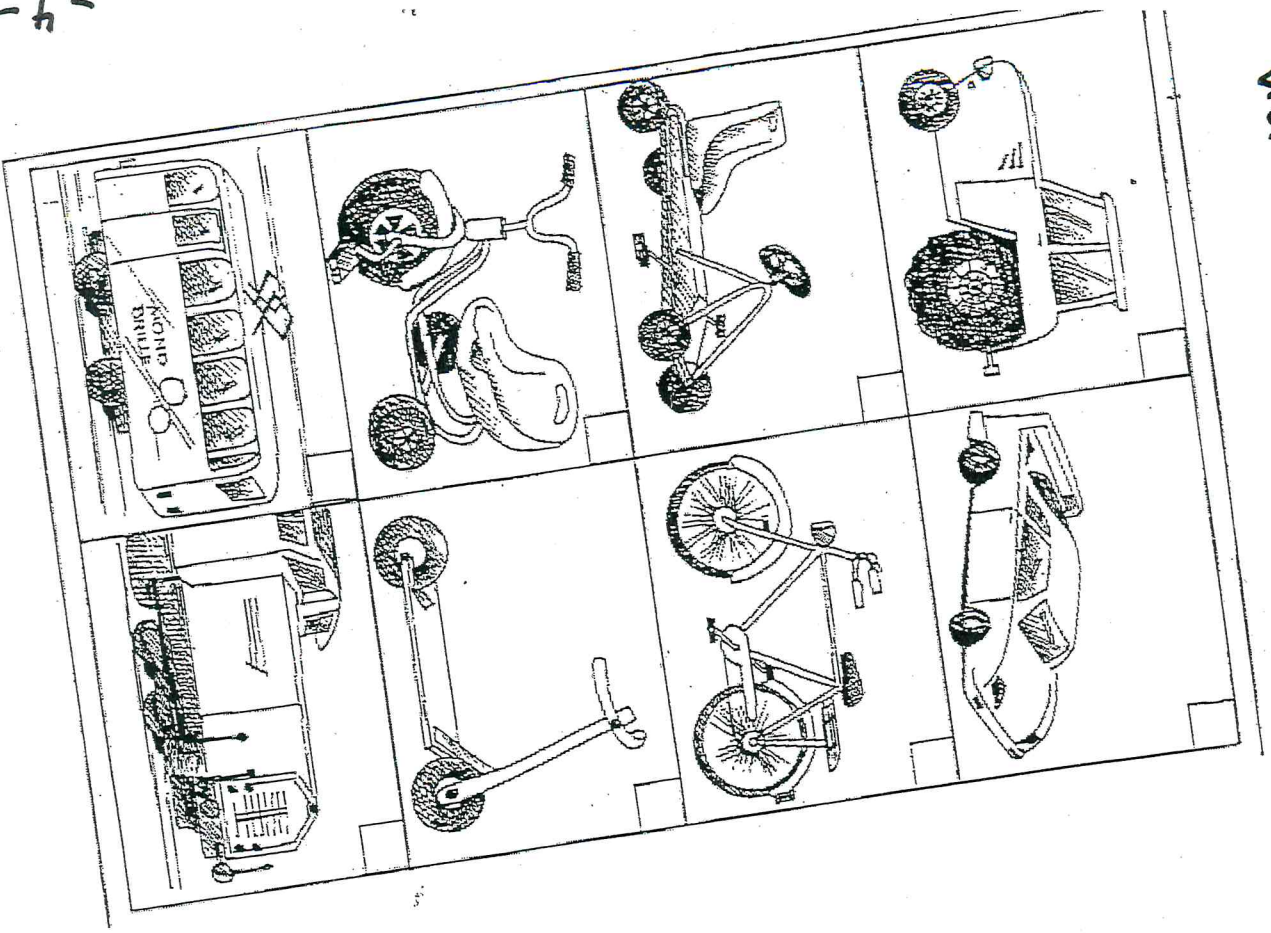

-4-

Kreuze bei jedem Bilderpaar das Schnellere an!  
Male das angekreuzte Bild aus!

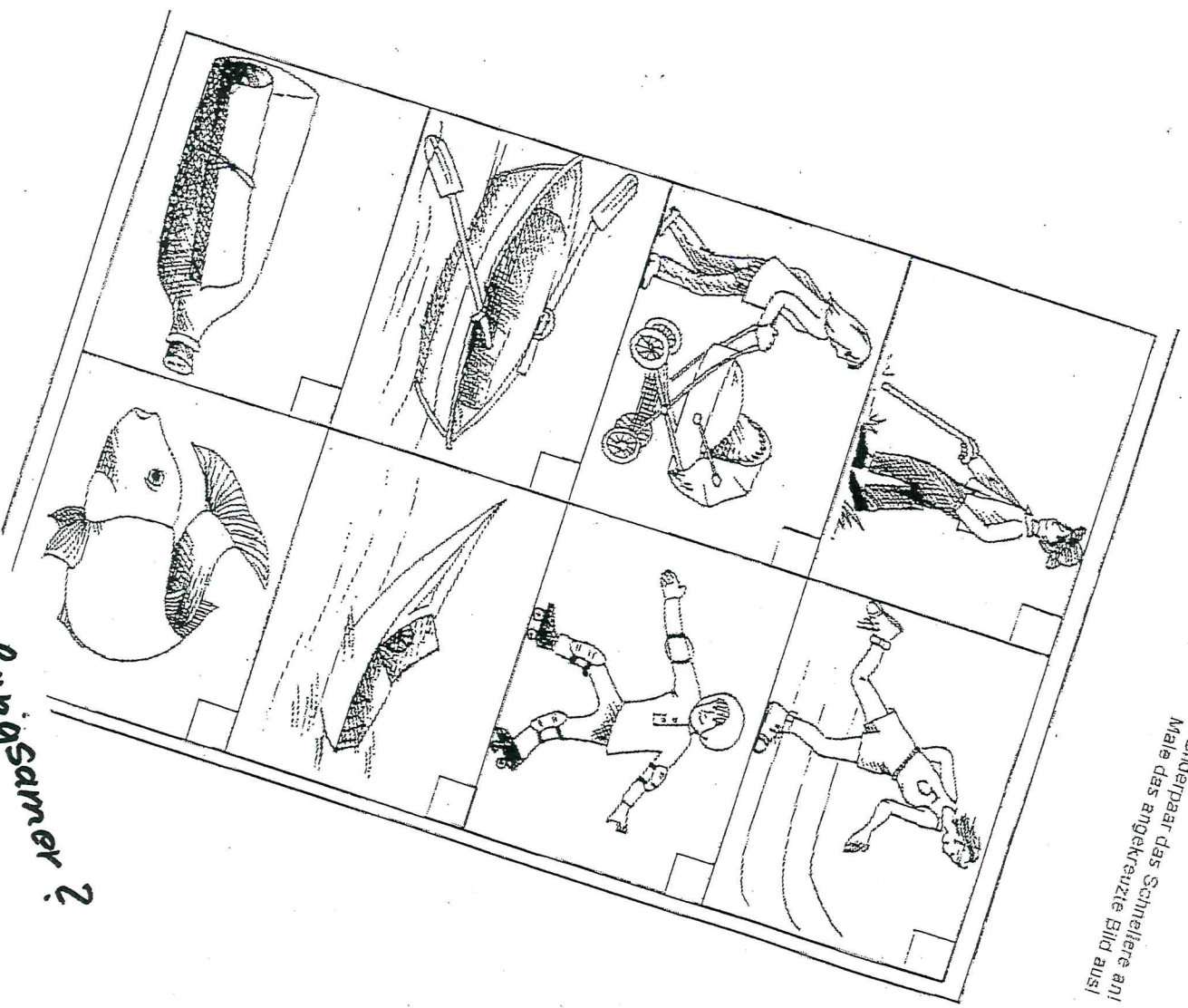

Wer ist langsamer ?

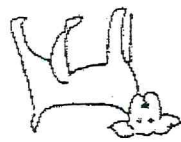
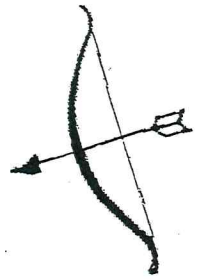
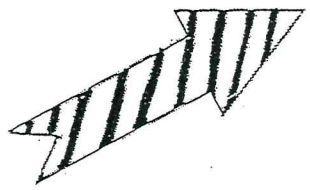
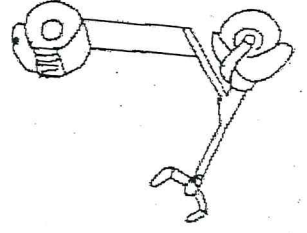
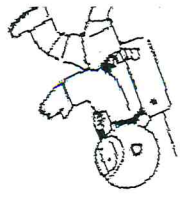

Pinks: blau

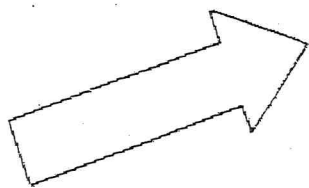
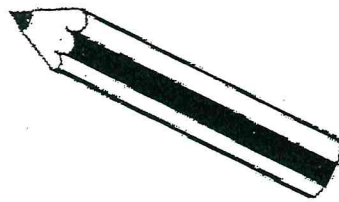
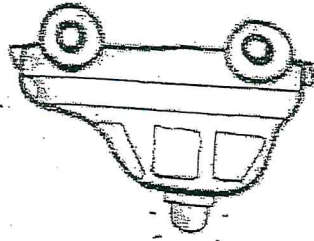
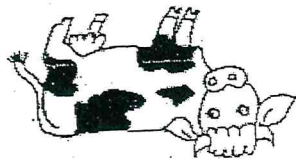
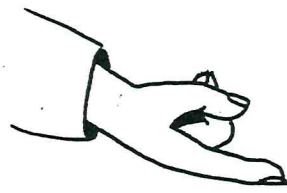

reds: rot

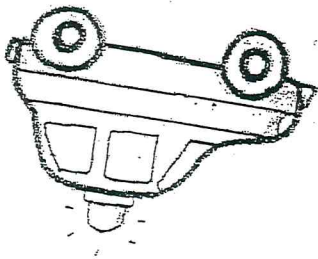
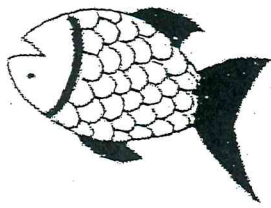
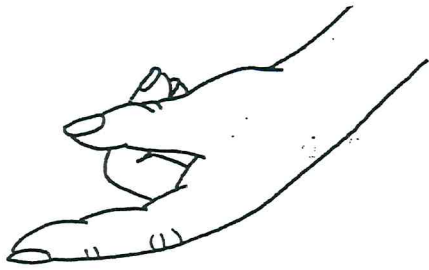
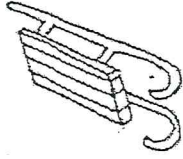
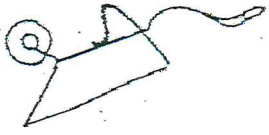



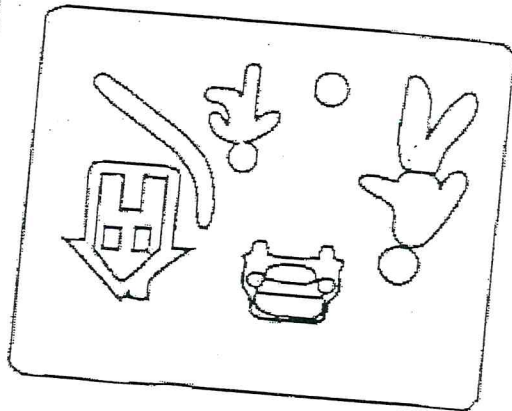
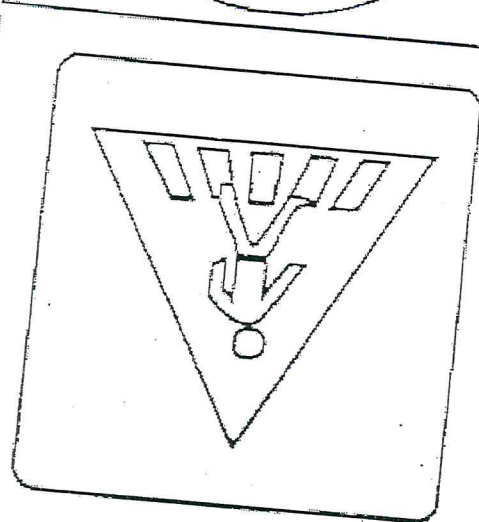
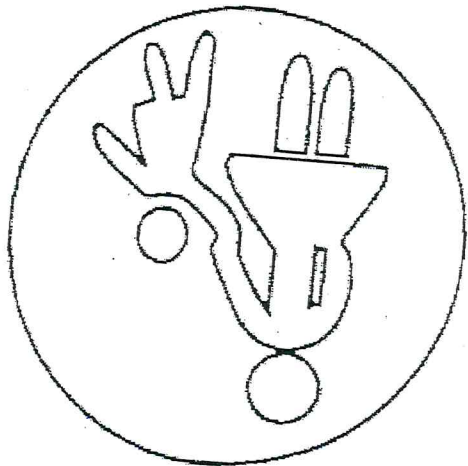
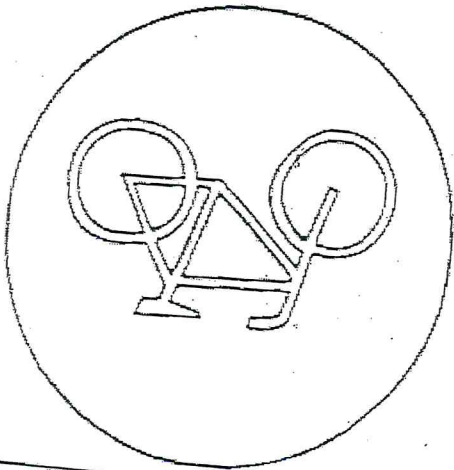
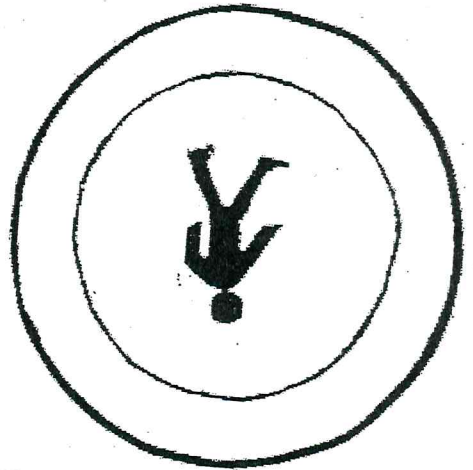
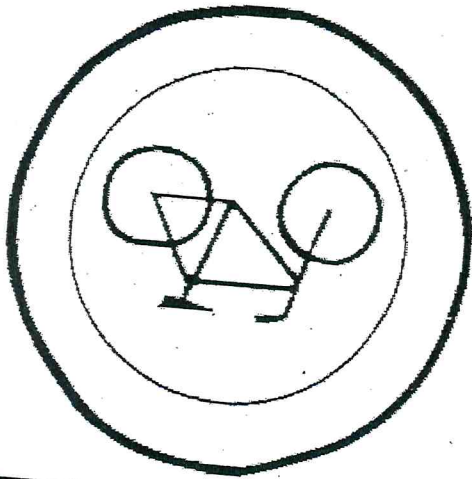

Kennst du diese Verkehrszeichen?  
Male sie richtig an!  
Merke: Rnd und rot, das ist ein Verbot!

Wichtige Verkehrszeichen

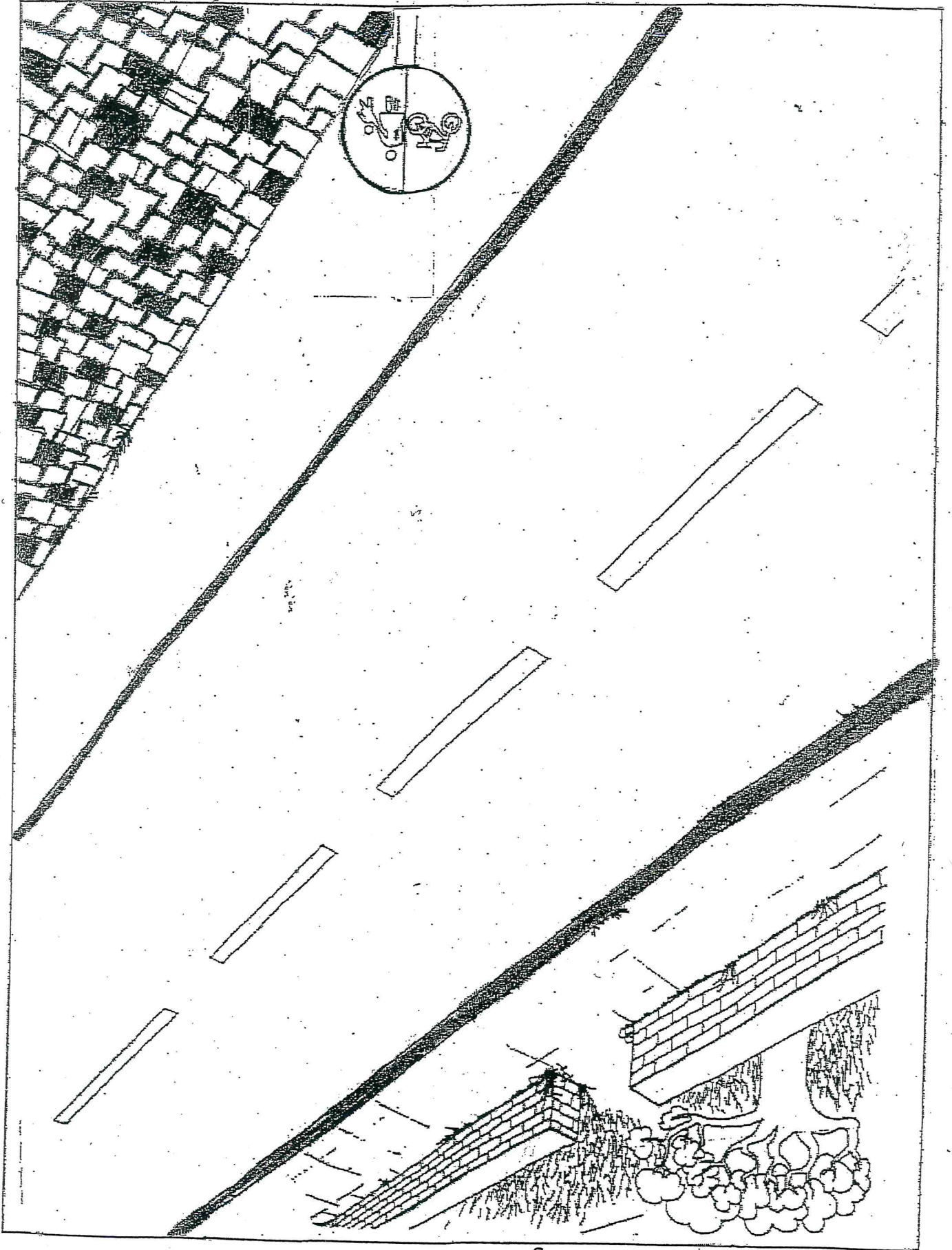

Wo ist 2

- Straße
- Fahrbahn
- Bürgersteig
- Bordsteinkante
- Fußweg
- Radweg

Die Straße

Schneide sie aus und klebe sie an die richtige Stelle auf Blatt 91!  
Wohin gehören diese Verkehrsteilnehmer?

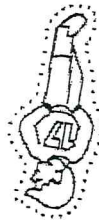
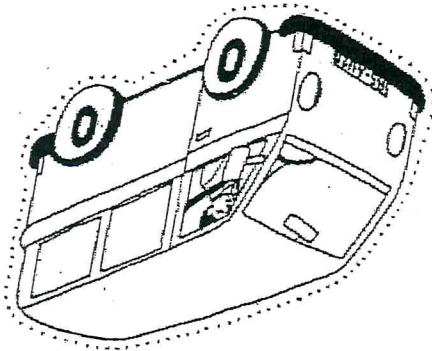
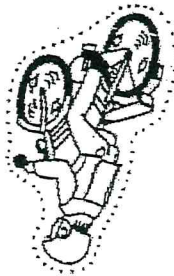
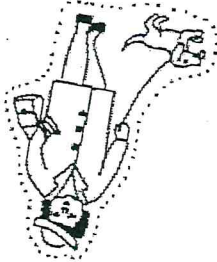
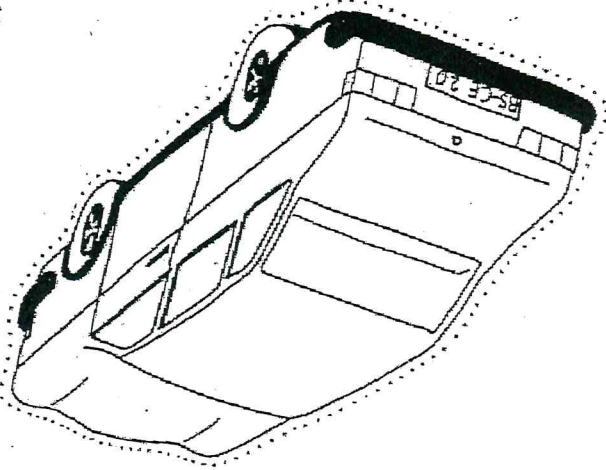
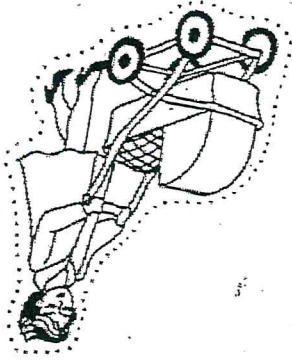



Überqueren der Straße an ungesicherter Stelle

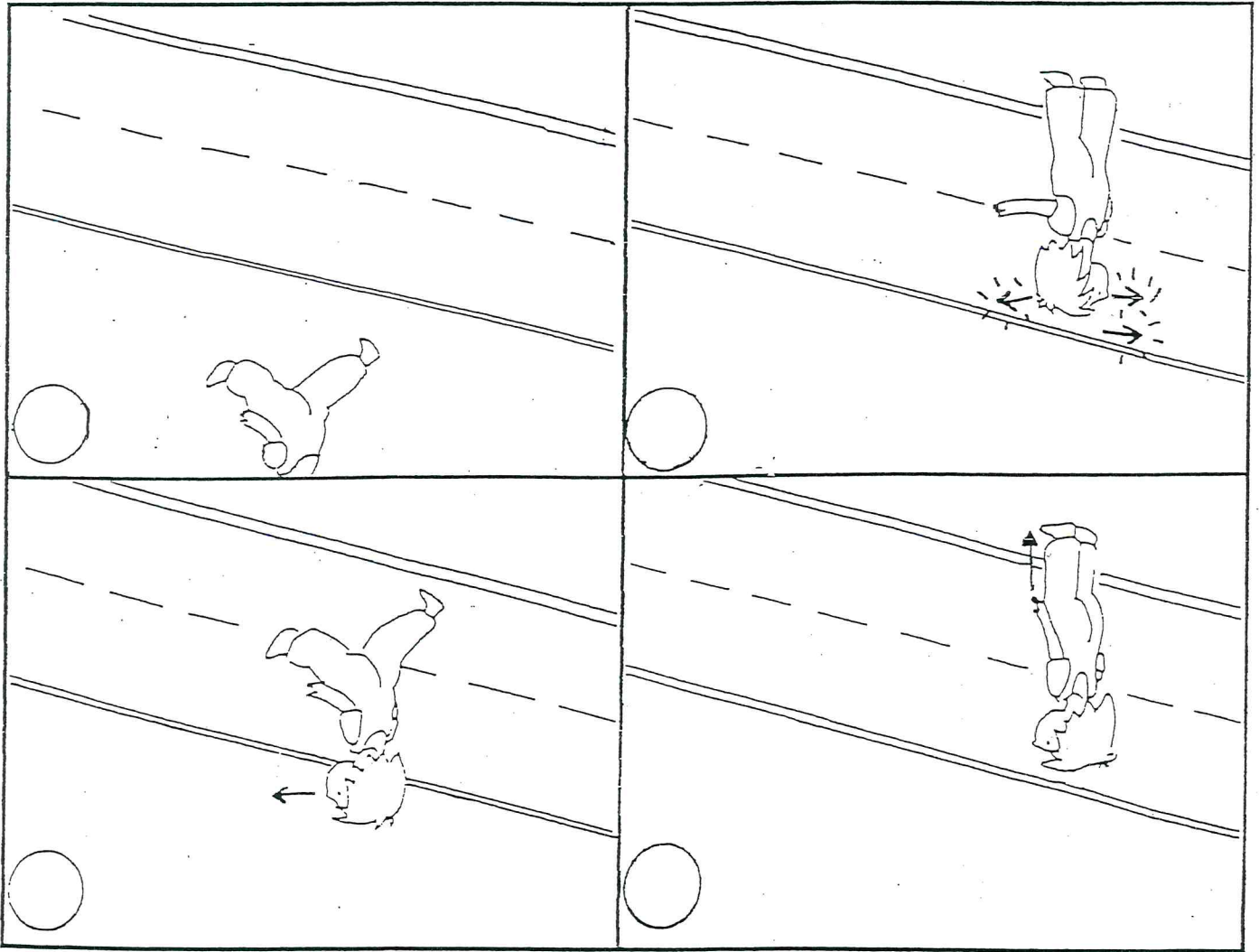

Nummere die Bilder in der richtigen Reihenfolge!

Überquerung der Straße an unübersichtlicher Stelle

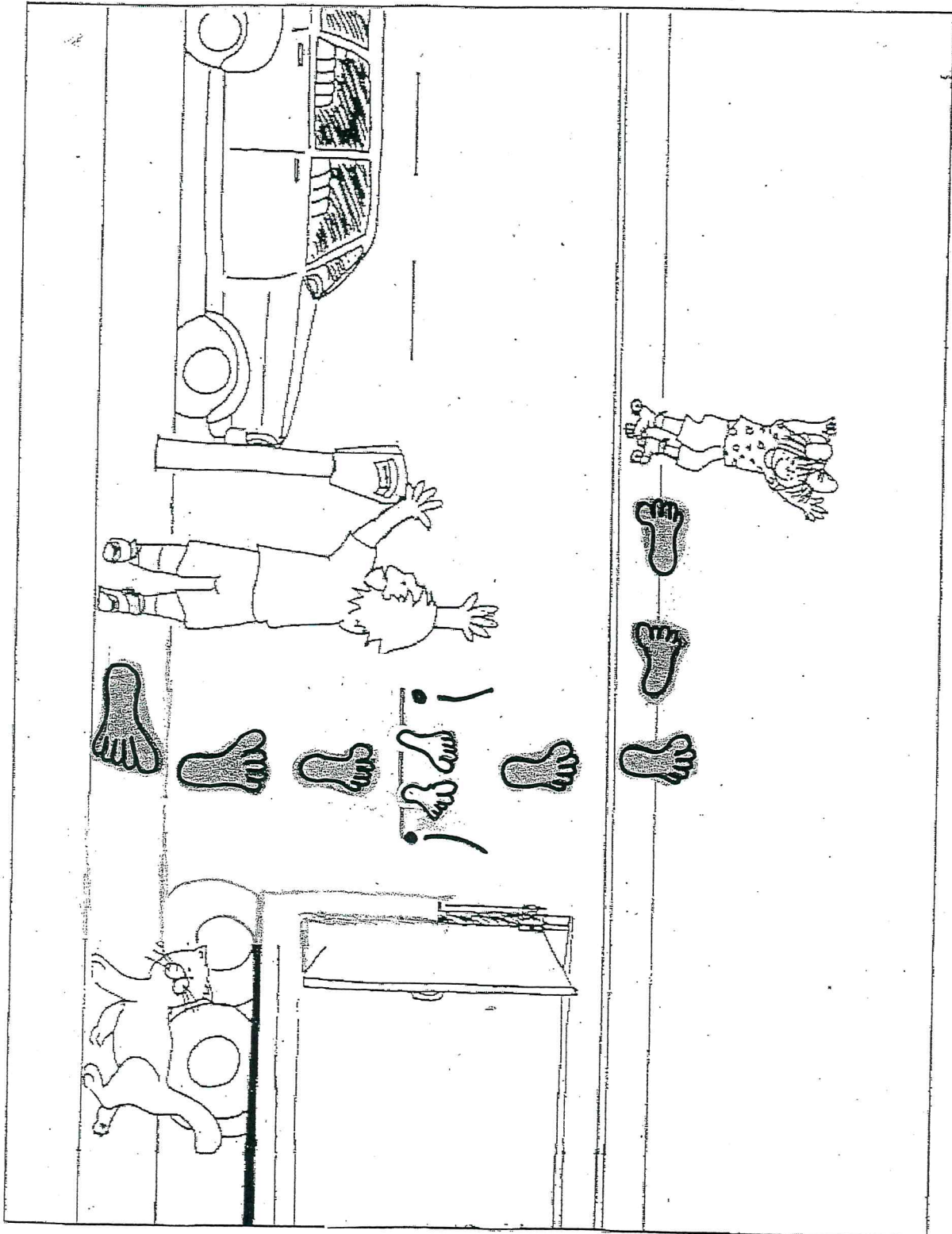

Was ist hier das Problem?  
Welche Lösungen fallen euch ein?  
(Eventuell AB als Folie kopieren)

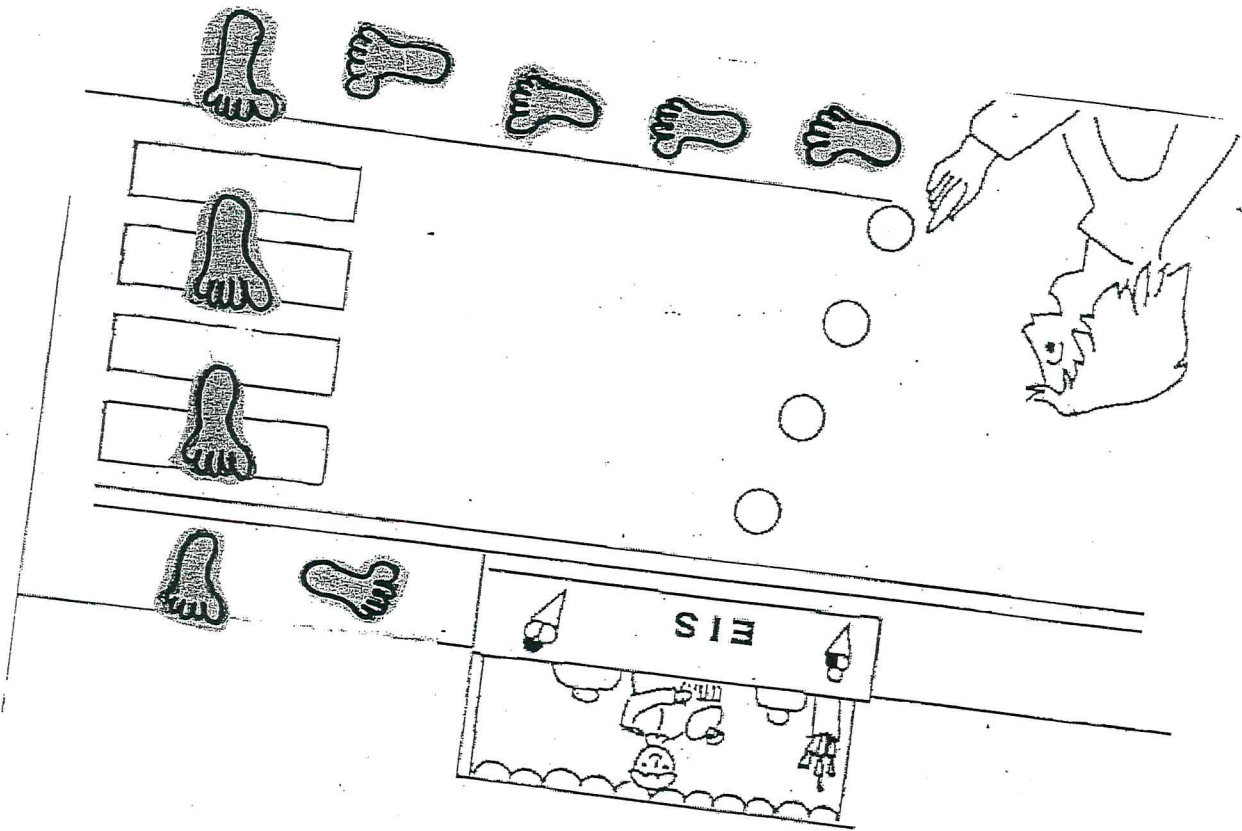
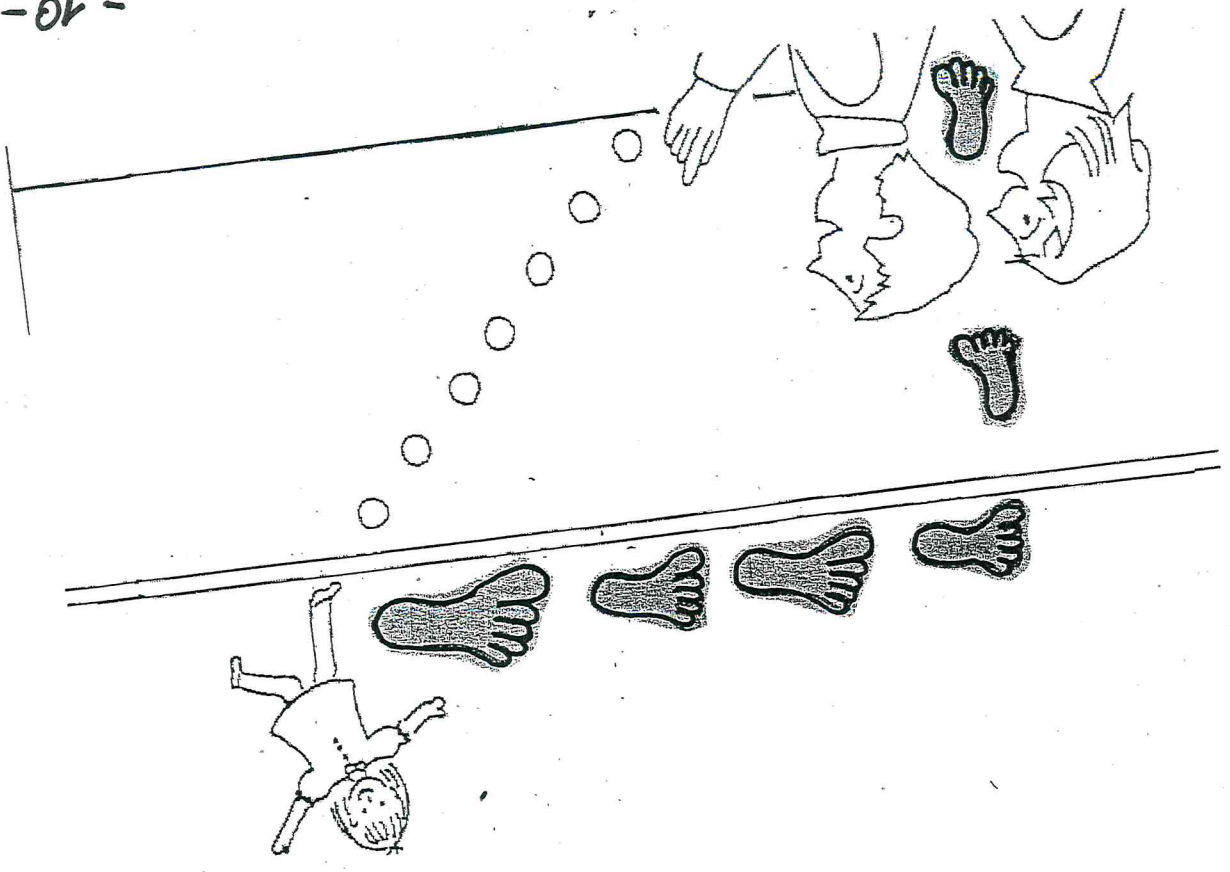

Wie überquert du die Straße am besten?

Der sicherste Weg



Ist das die richtige Reihenfolge?

Male an, schneide aus und klebe die Bilder in der richtigen Reihenfolge auf Blatt 11a.

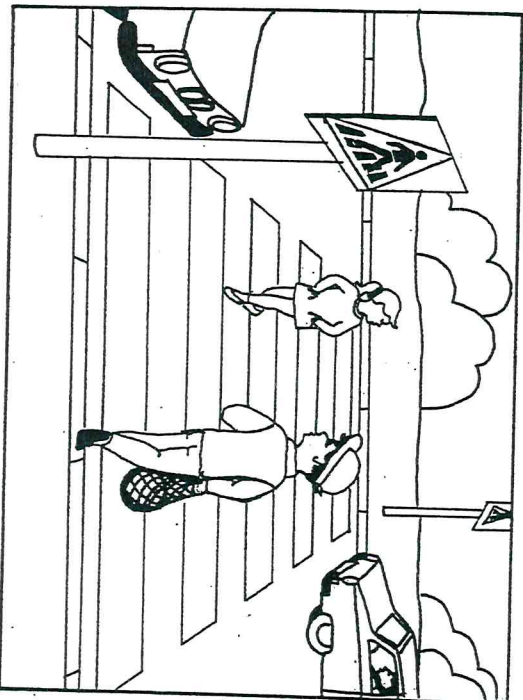
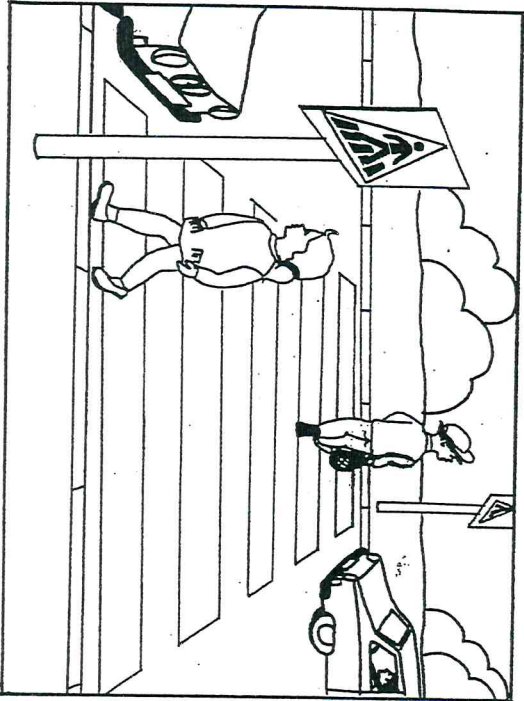
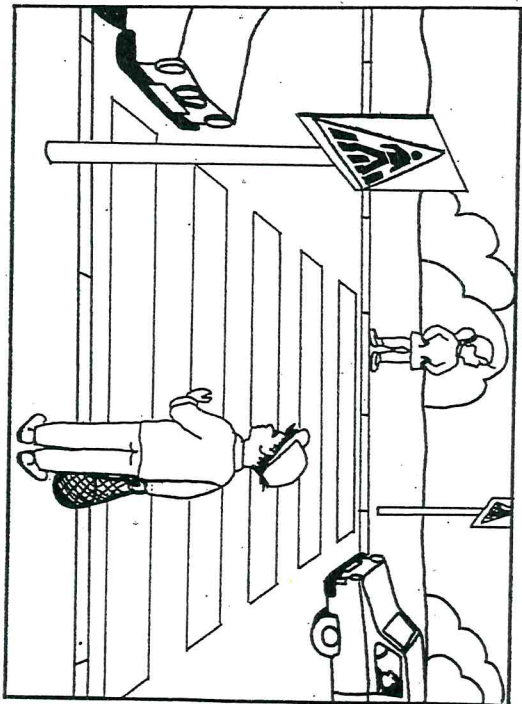
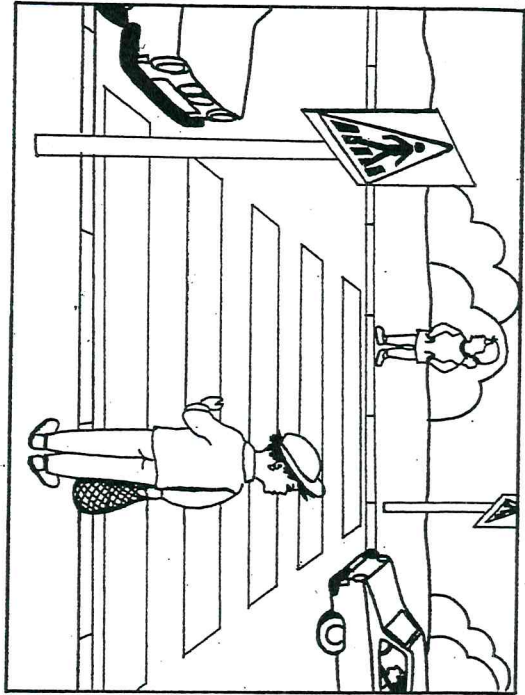

Name: \_\_\_\_\_



Wie verhältst du dich am Zebrastrifen am sichersten? Klebe die Bilder von Blatt 11b in der richtigen Reihenfolge auf und schreibe die richtigen Texte darunter!

1

2

3

4

Name:



- 11b -

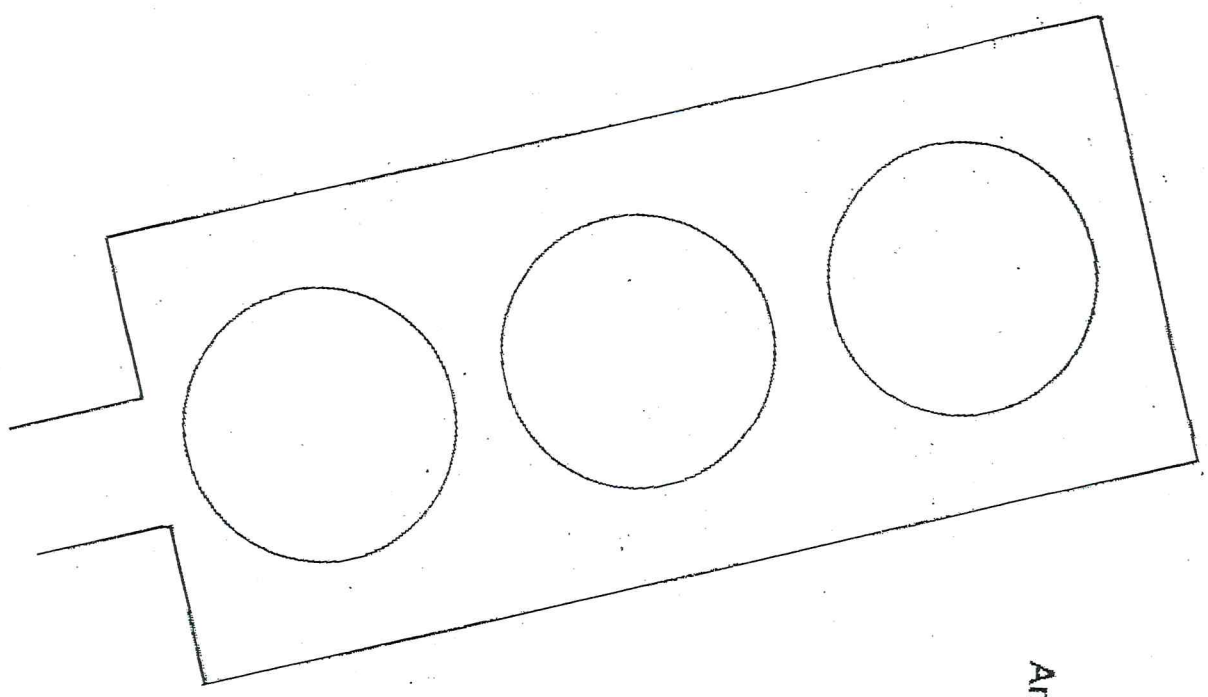

Ampeln für Autos und Fußgänger

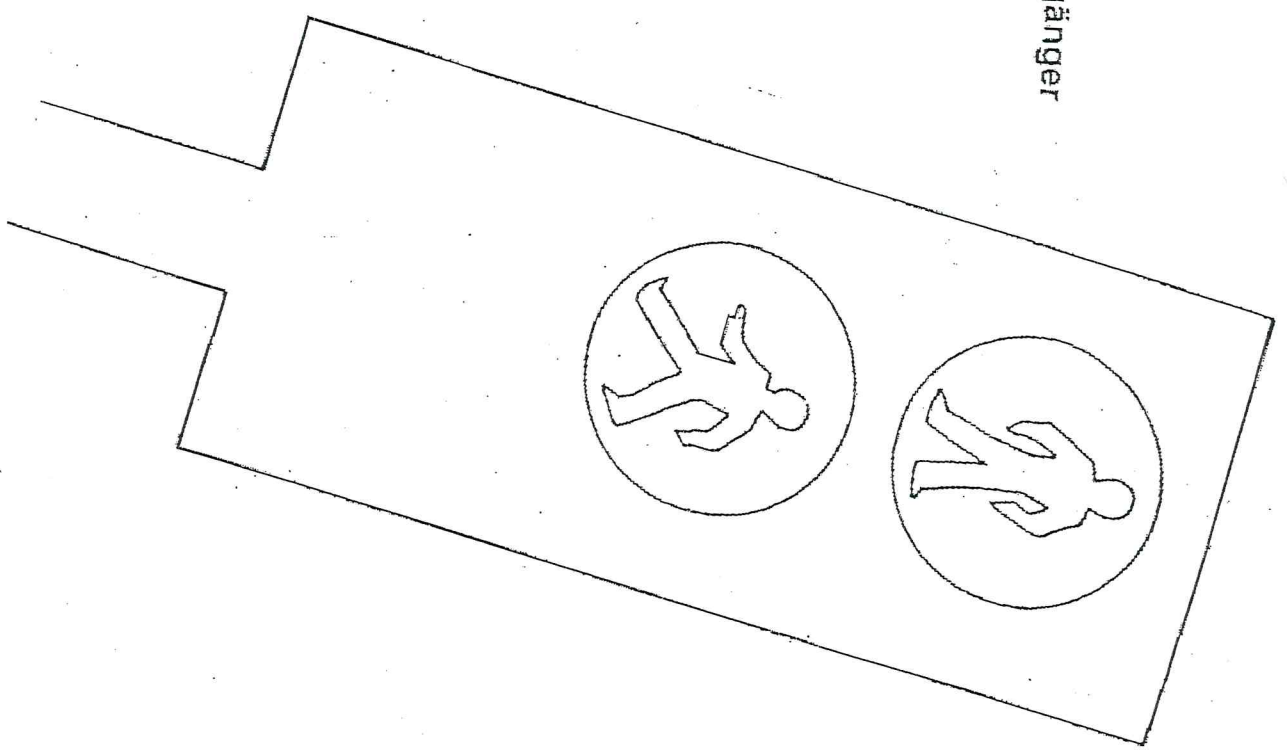

Kenntst du die Ampelfarben?  
Male beide Ampeln an!



Schneide aus! Klebe an die richtige Stelle! Nimm die richtige Farbe!

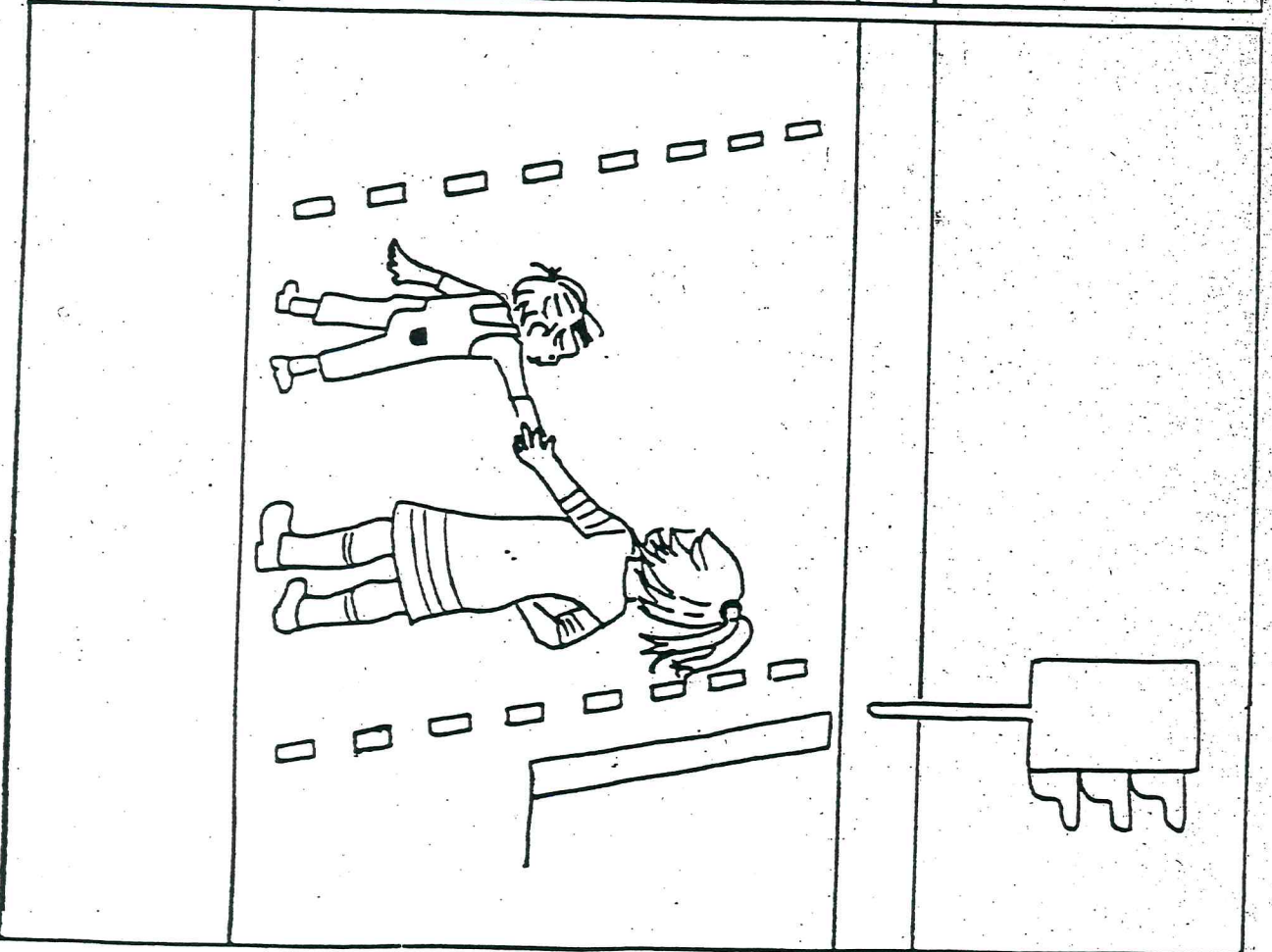
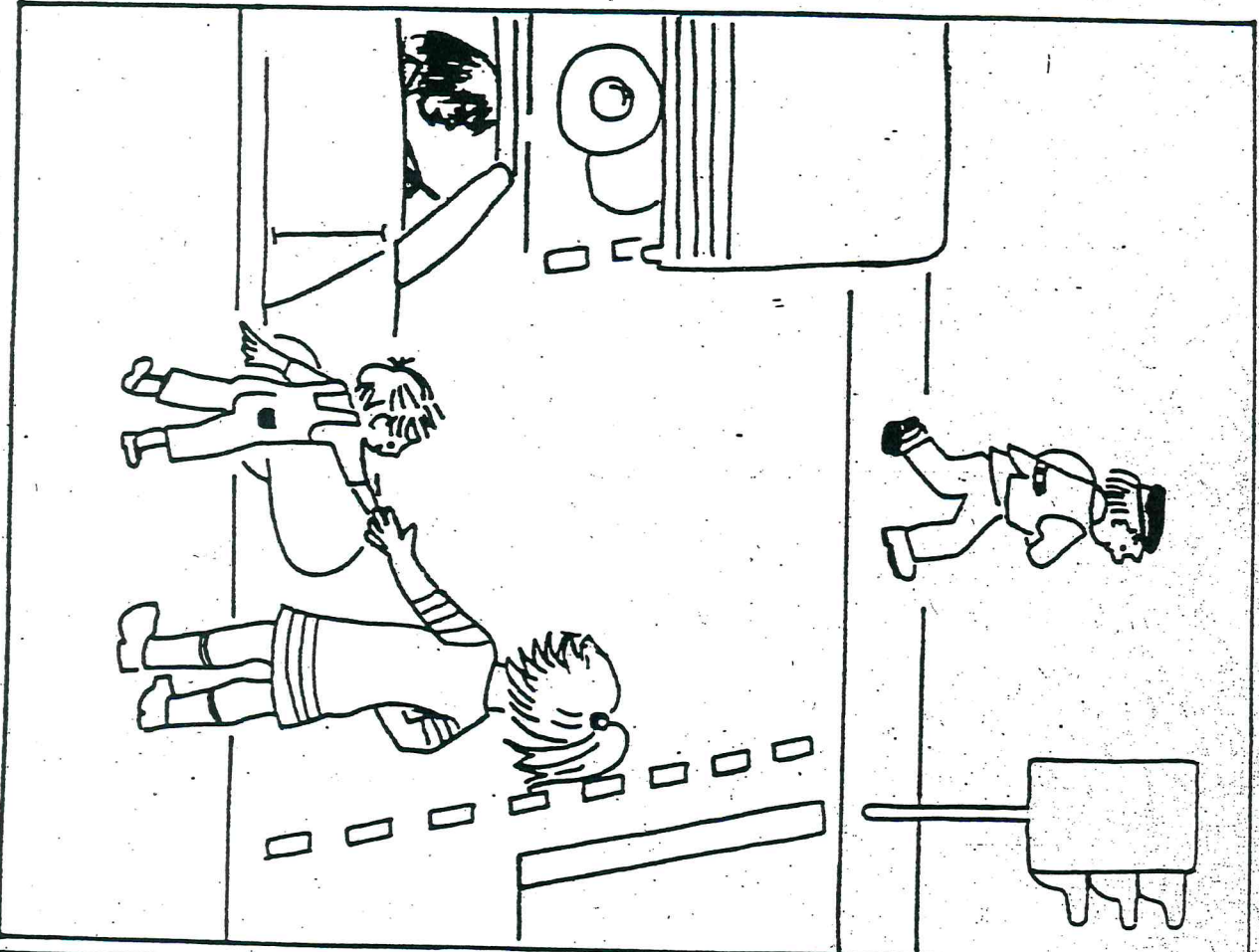
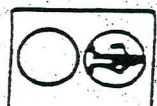
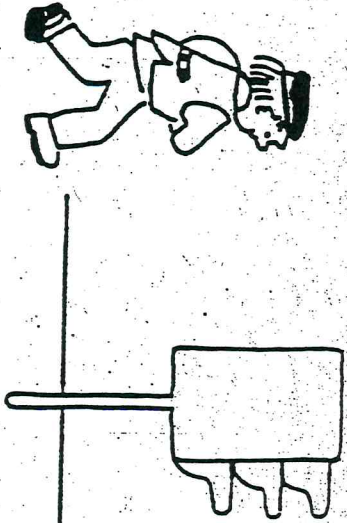

Ich tünge  
Notfall

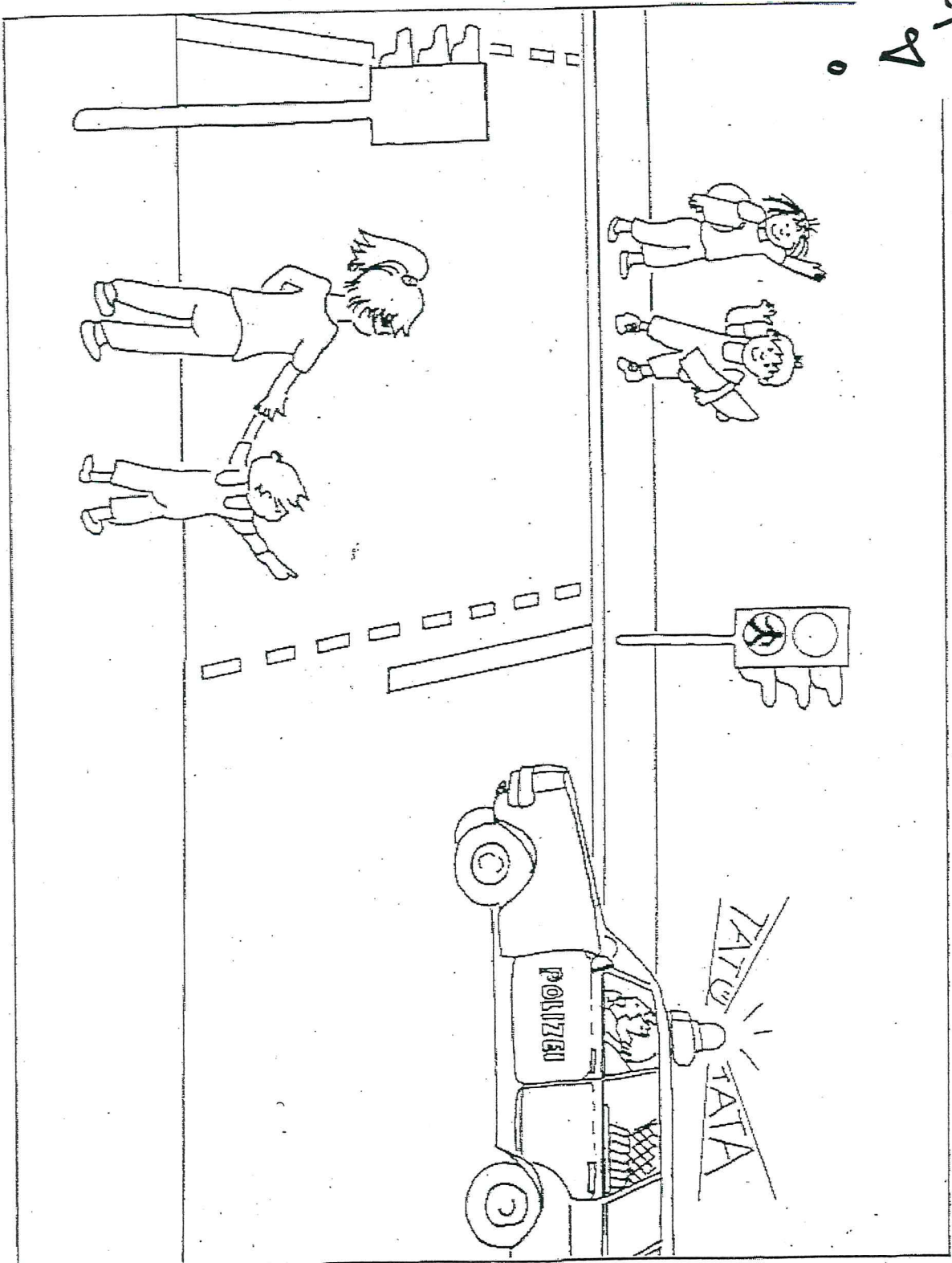

Erzähle, wie du dich trotzdem verhältst!  
Die Ampel ist grün.

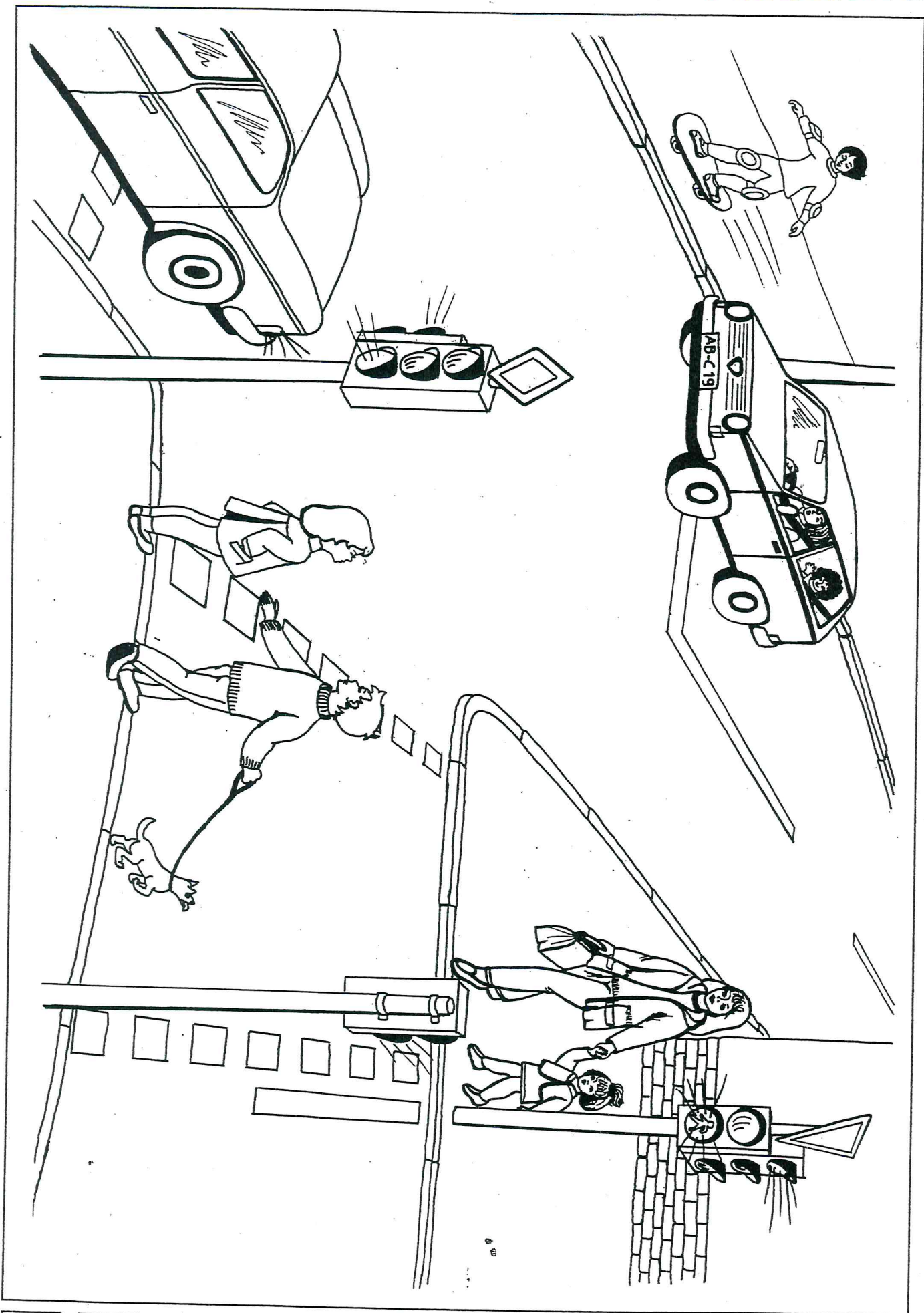

Wo lauert hier die Gefahr?

Erzähle und male das Fahrzeug, das rechts abbiegen will, rot an!

Name: \_\_\_\_\_

